

5/8-11 THREAD x 1-1/8 DEEP
 Ø.642 C'BORE x .300 DEEP

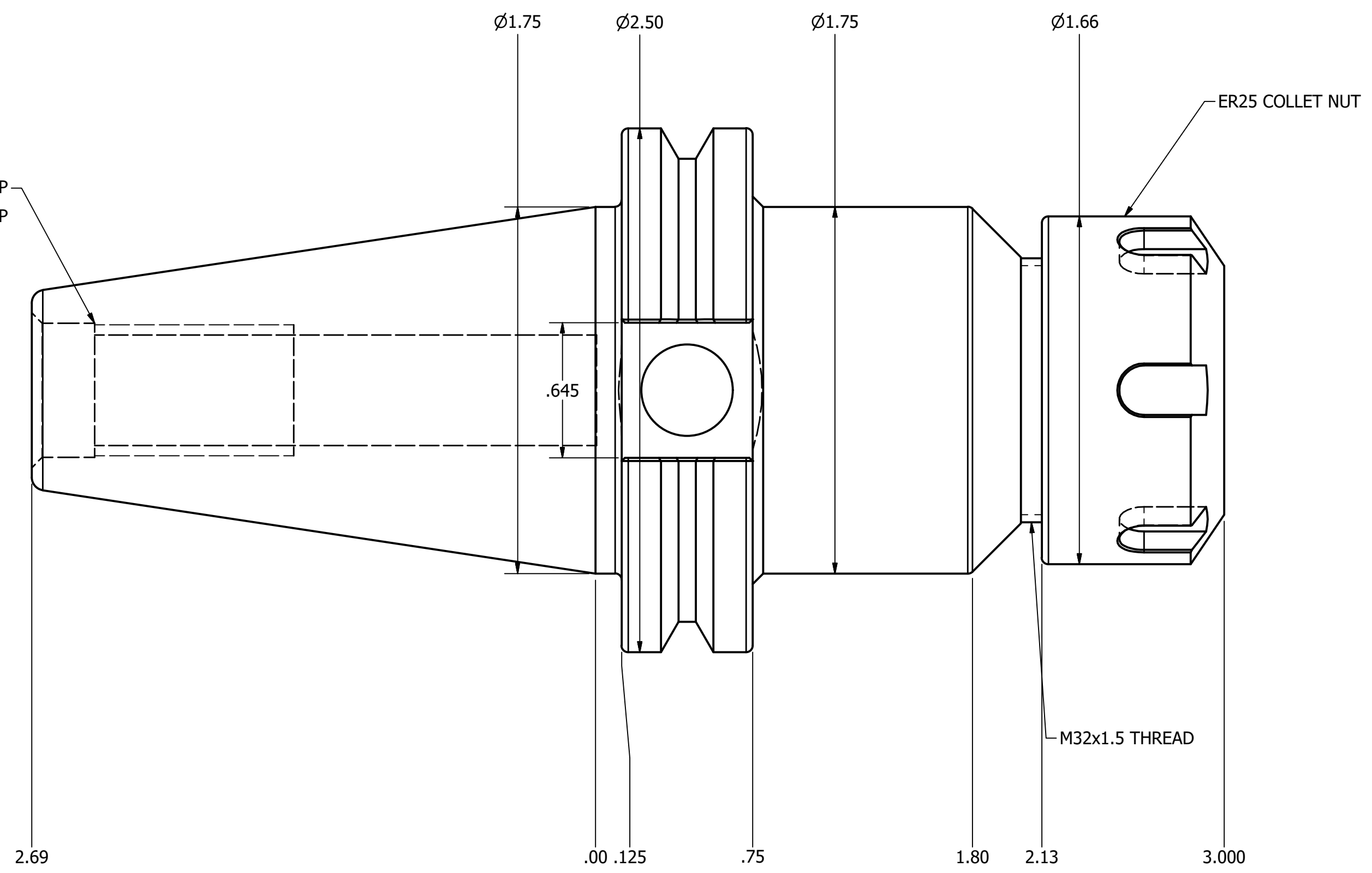

NOTES:
 TAKES ALL ER25 COLLETS FROM .024"-.6875"
 USES WRENCH PART #ER25-WRENCH (NOT INCLUDED)
 FOR MORE PRODUCT DETAILS PLEASE GO TO MARITOO.COM
 AND SEARCH ITEM # LISTED ON THIS PRINT

MARITOO	
www.maritool.com	
ITEM#	CAT40-ER25-3.0
Made in USA	