

5/8-11 THREAD x 1-1/8 DEEP  
Ø.642 C'BORE x .300 DEEP

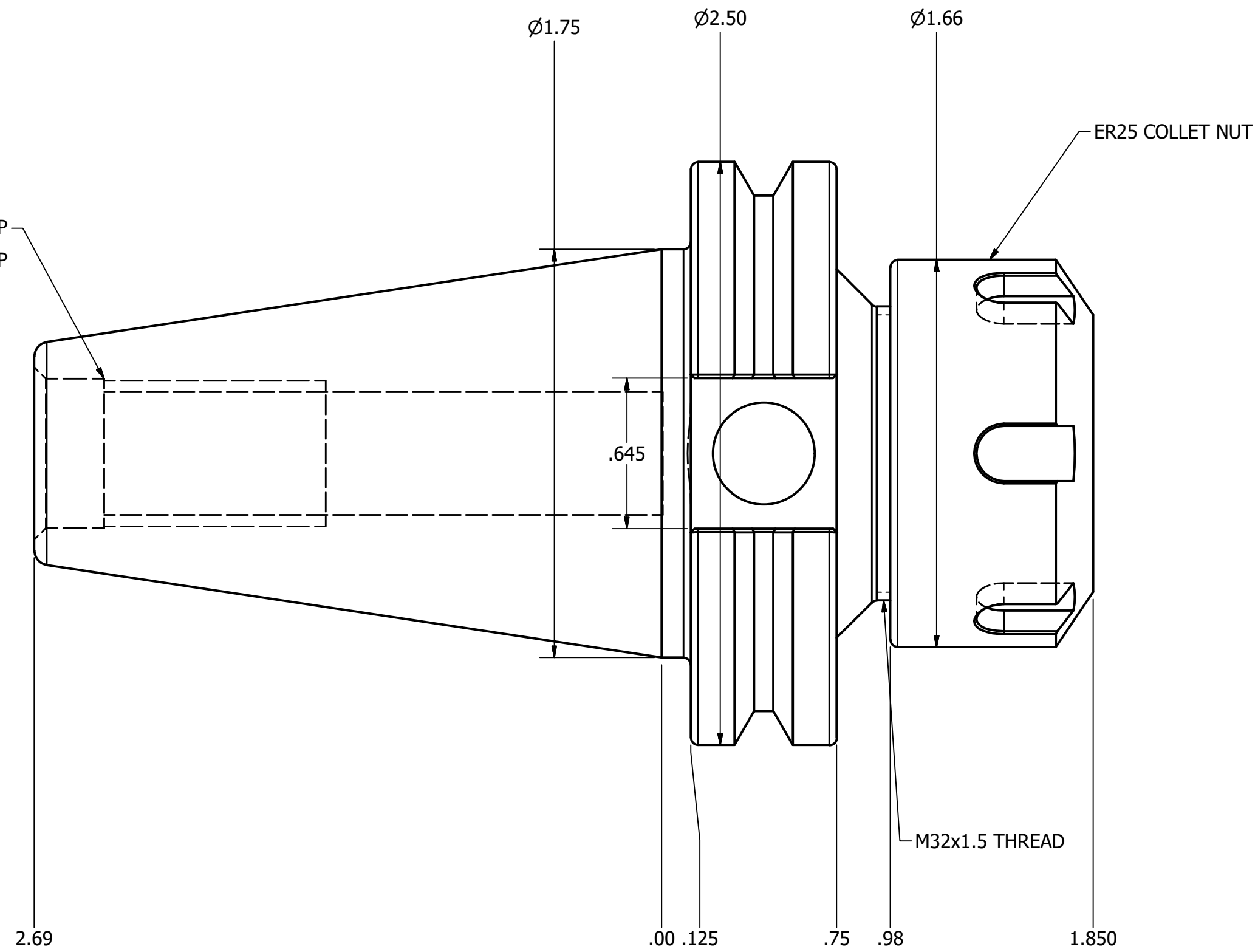

NOTES:  
TAKES ALL ER25 COLLETS FROM .024"-.6875"  
USES WRENCH PART #ER25-WRENCH (NOT INCLUDED)  
FOR MORE PRODUCT DETAILS PLEASE GO TO MARITOO.COM  
AND SEARCH ITEM # LISTED ON THIS PRINT

**MARITOOOL**

www.maritool.com

ITEM# **CAT40-ER25-1.85**

Made in USA