

5/8-11 THREAD x 1-1/8 DEEP
 Ø.642 C'BORE x .300 DEEP

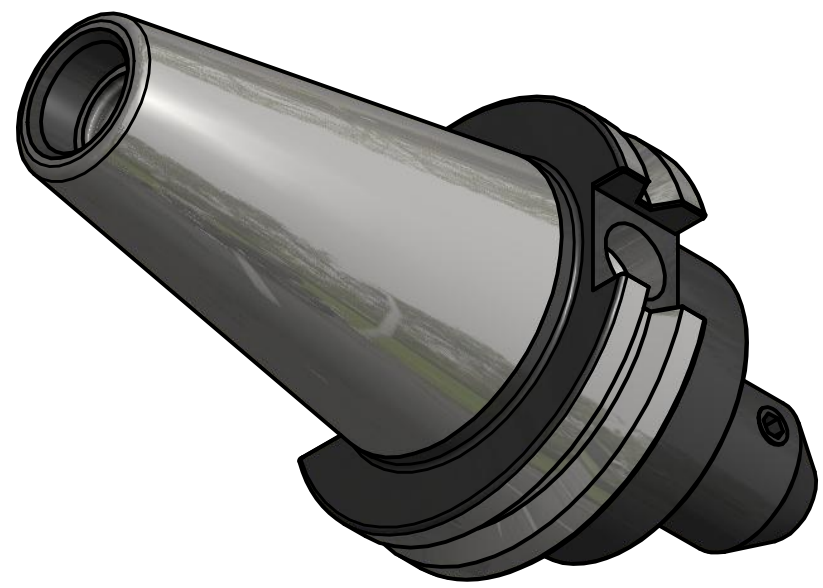
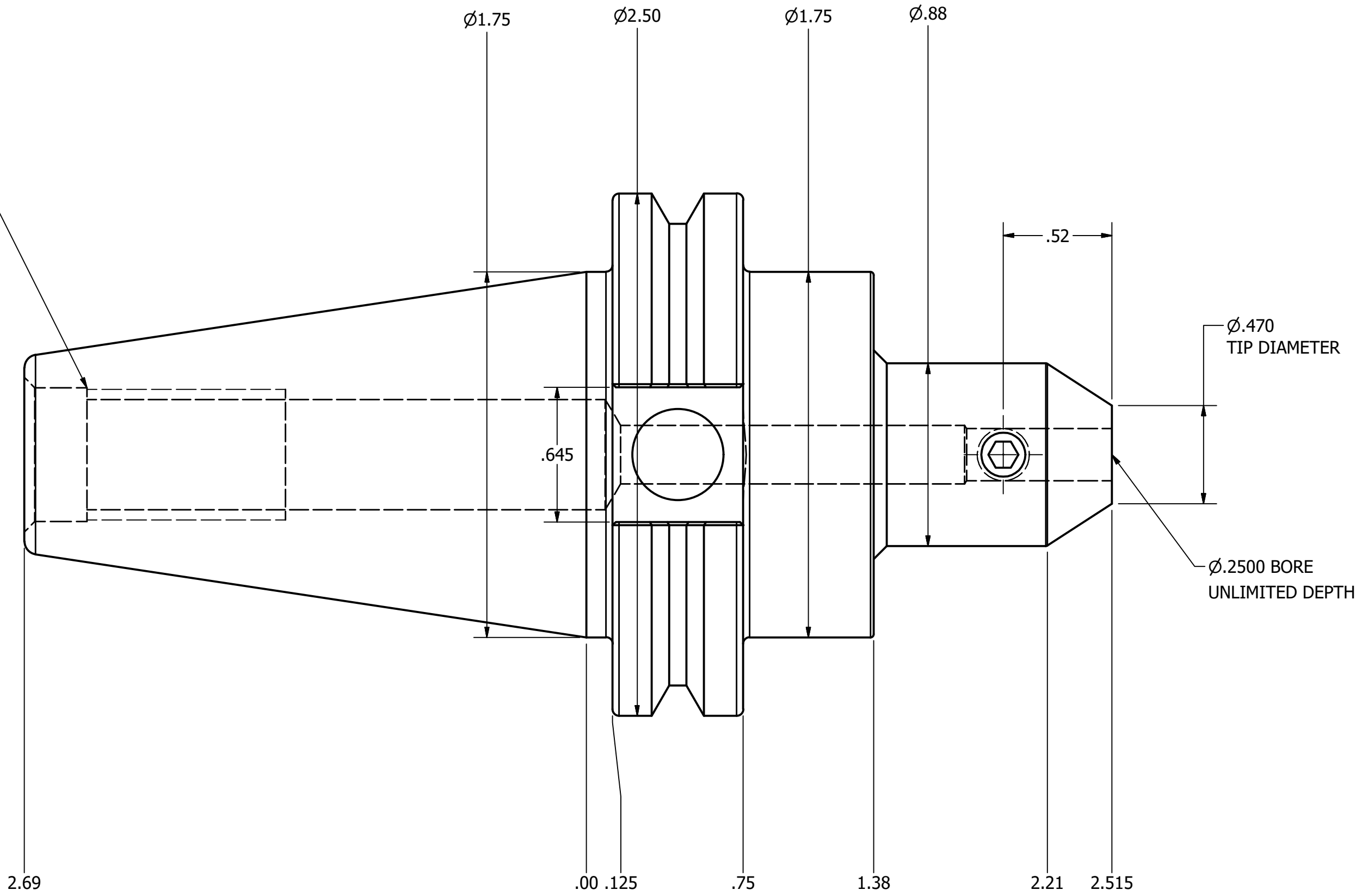

NOTES:
 HOLDER USES 1/4-28 SET SCREW, PART #SS070
 FOR MORE PRODUCT DETAILS PLEASE GO TO MARITOO.COM
 AND SEARCH ITEM # LISTED ON THIS PRINT

MARITOO

www.maritool.com

ITEM# **CAT40-EM.250-2.5**

Made in USA