

5/8-11 THREAD x 1-1/8 DEEP
 Ø.642 C'BORE x .300 DEEP

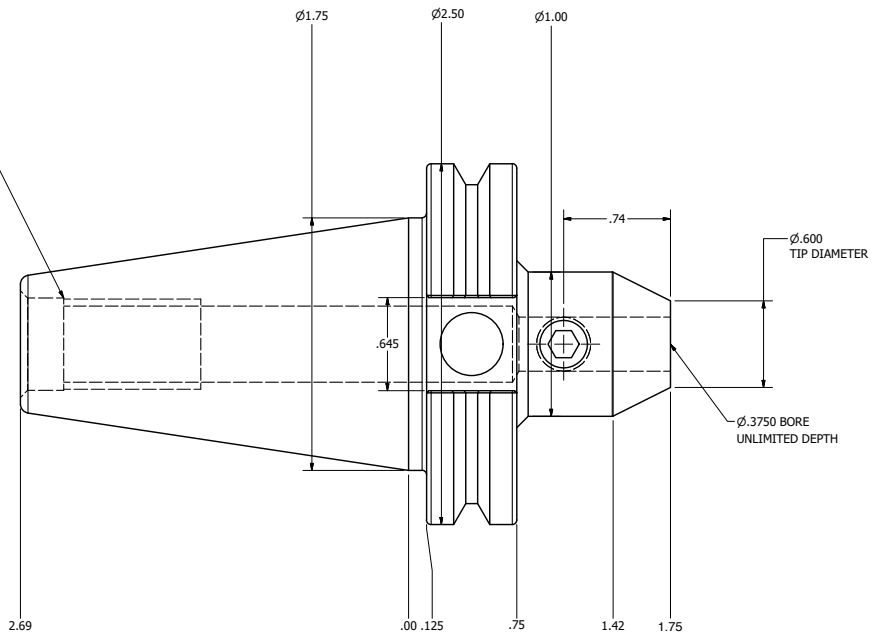

NOTES:
 HOLDER USES 3/8-24 SET SCREW, PART #SS120
 FOR MORE PRODUCT DETAILS PLEASE GO TO MARITOO.COM
 AND SEARCH ITEM # LISTED ON THIS PRINT

MARITOO

www.maritool.com

ITEM# **CAT40-EM.375-1.75**

Made in USA