

5/8-11 THREAD x 1-1/8 DEEP
 Ø .642 C'BORE DIA .300 DEEP

PRECISION GROUND
 FOR DUAL CONTACT FIT

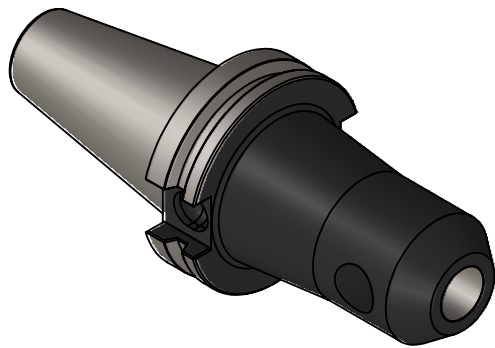
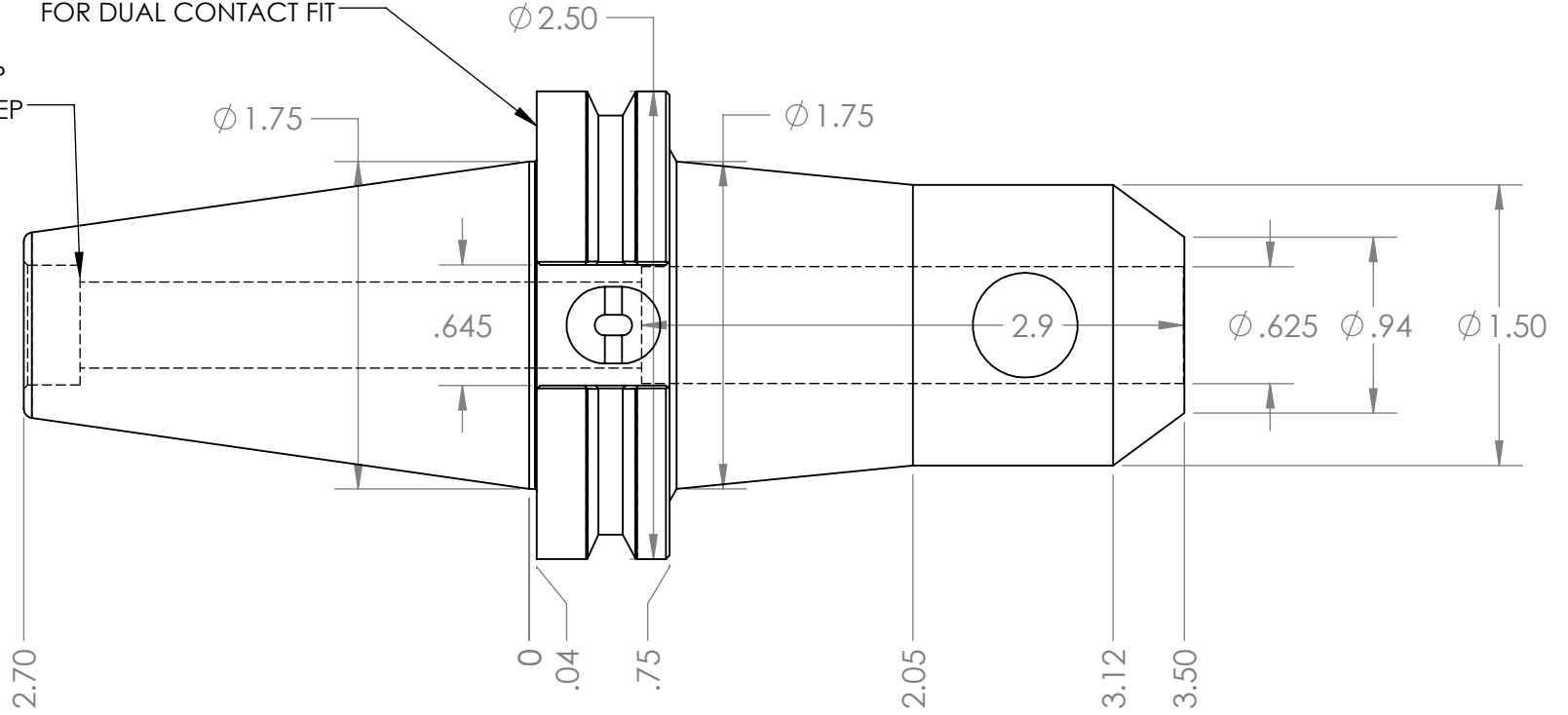

NOTES:
 HOLDER USES 9/16 - 18 SET SCREW, PART #SS210
 WORKS ON ALL CAT40 MACHINES WITH DUAL CONTACT SPINDLES
 COMPATIBLE WITH BIG-PLUS® SPINDLES
 ACCEPTS .625 SHANK TOOLING
 FOR MORE PRODUCT DETAILS PLEASE GO TO MARITOO.COM
 AND SEARCH ITEM # LISTED ON THIS PRINT

MARITOO

WWW.MARITOO.COM

ITEM# **CAT40 EM .625-3.5DT**

Made in USA