

5/8-11 THREAD x 1-1/8 DEEP  
 Ø.642 C'BORE x .300 DEEP

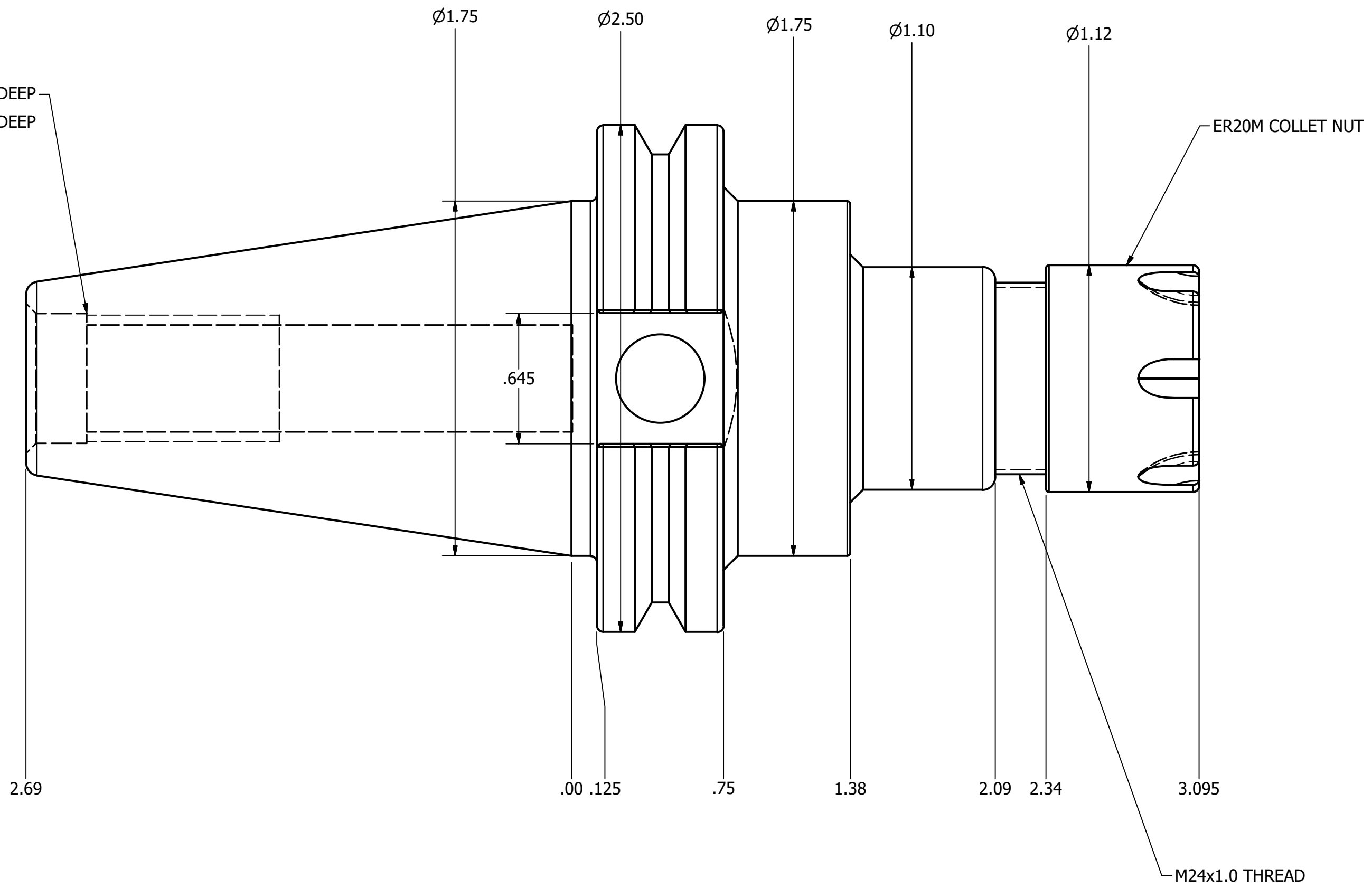

NOTES:  
 TAKES ALL ER20 COLLETS FROM .039"-.5625"  
 USES WRENCH PART #ER20M-WRENCH (NOT INCLUDED)  
 FOR MORE PRODUCT DETAILS PLEASE GO TO MARITOO.COM  
 AND SEARCH ITEM # LISTED ON THIS PRINT

<b>MARITOO</b>	
www.maritool.com	
ITEM#	<b>CAT40-ER20-3.0M</b>
Made in USA	