

M12x1.75 THREAD x 1.00 DEEP
C'BORE DIA .492 x .236 DEEP

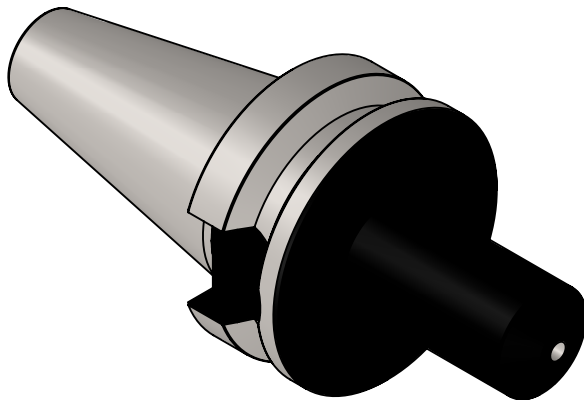
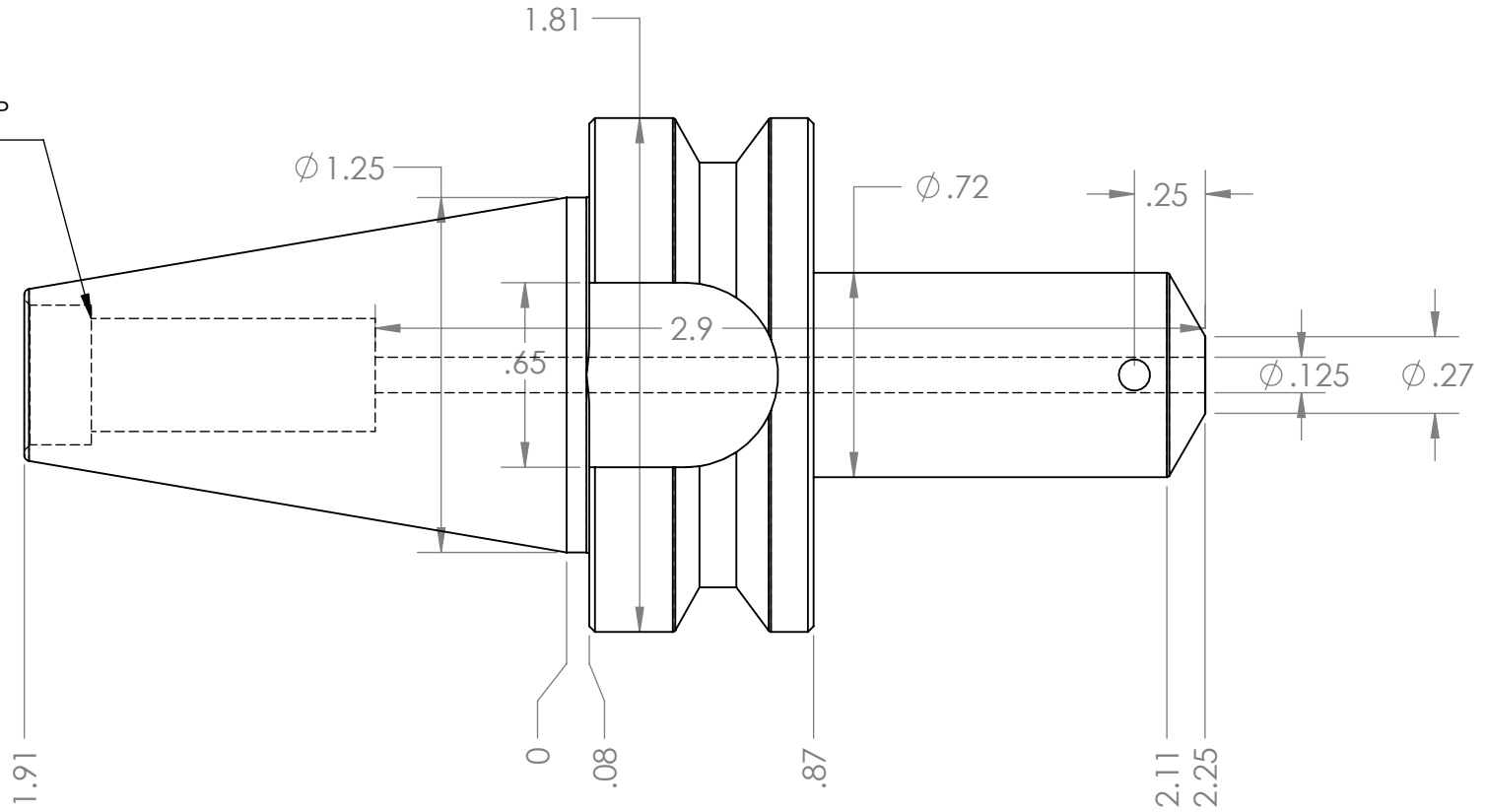

NOTES:
HOLDER USES 10 - 32 SET SCREW, PART #SS020
ACCEPTS .125 SHANK TOOLING
FOR MORE PRODUCT DETAILS PLEASE GO TO MARITOO.COM
AND SEARCH ITEM # LISTED ON THIS PRINT

MARITOO

WWW.MARITOO.COM

ITEM# **BT30 EM.125-2.25**

Made in USA