

5/8-11 THREAD x 1-1/8 DEEP
Ø.642 C'BORE x .300 DEEP

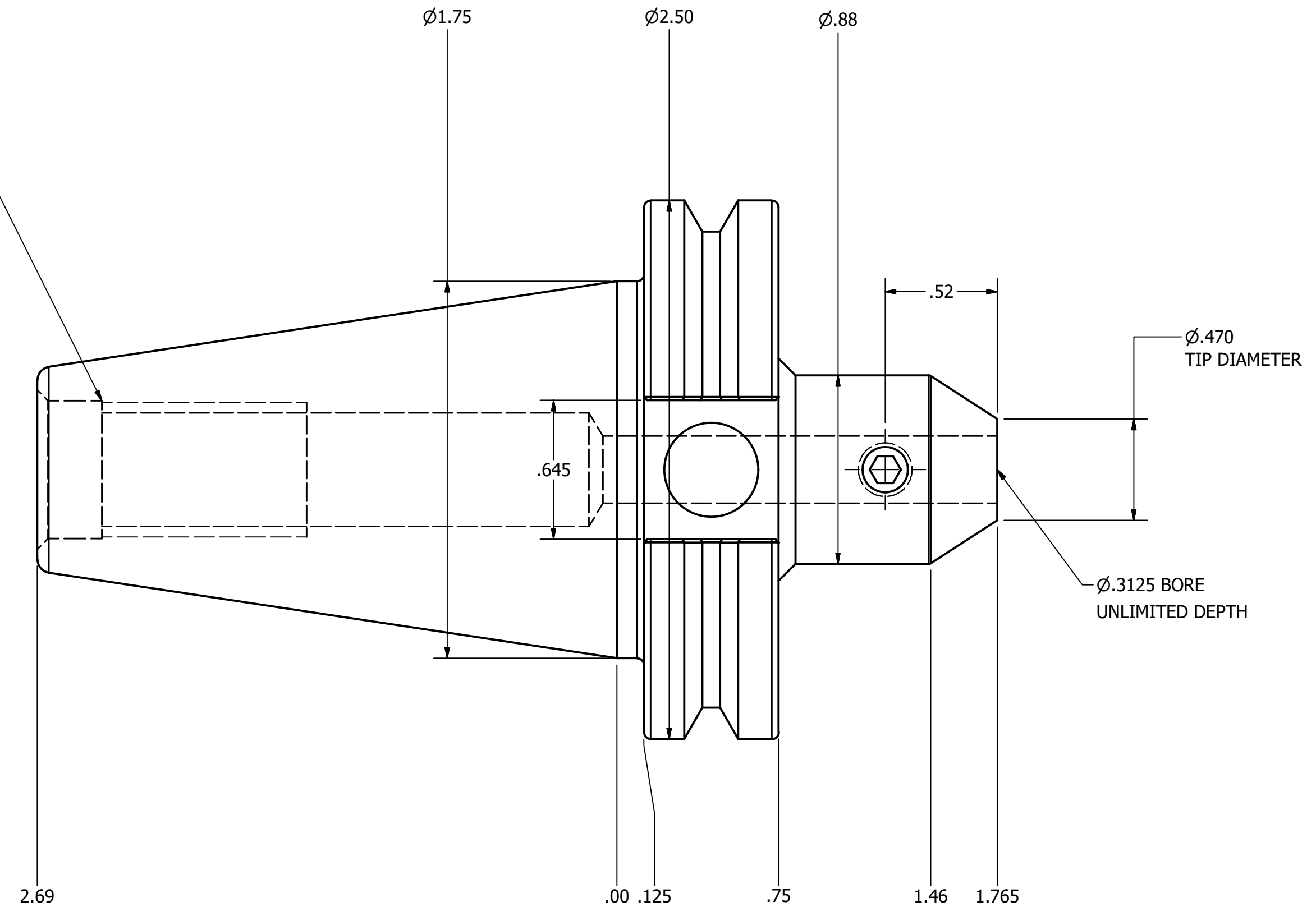

NOTES:
HOLDER USES 1/4-28 SET SCREW, PART #SS090
FOR MORE PRODUCT DETAILS PLEASE GO TO MARITOO.COM
AND SEARCH ITEM # LISTED ON THIS PRINT

MARITOO	
www.maritool.com	
ITEM#	CAT40-EM.3125-1.75
Made in USA	