

M12x1.75 THREAD x 1.00 DEEP
 C'BORE DIA .492 x .236 DEEP

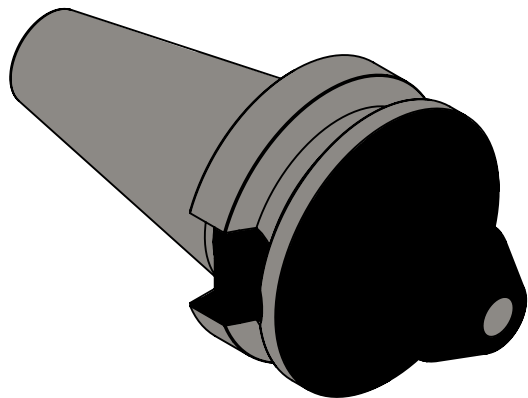
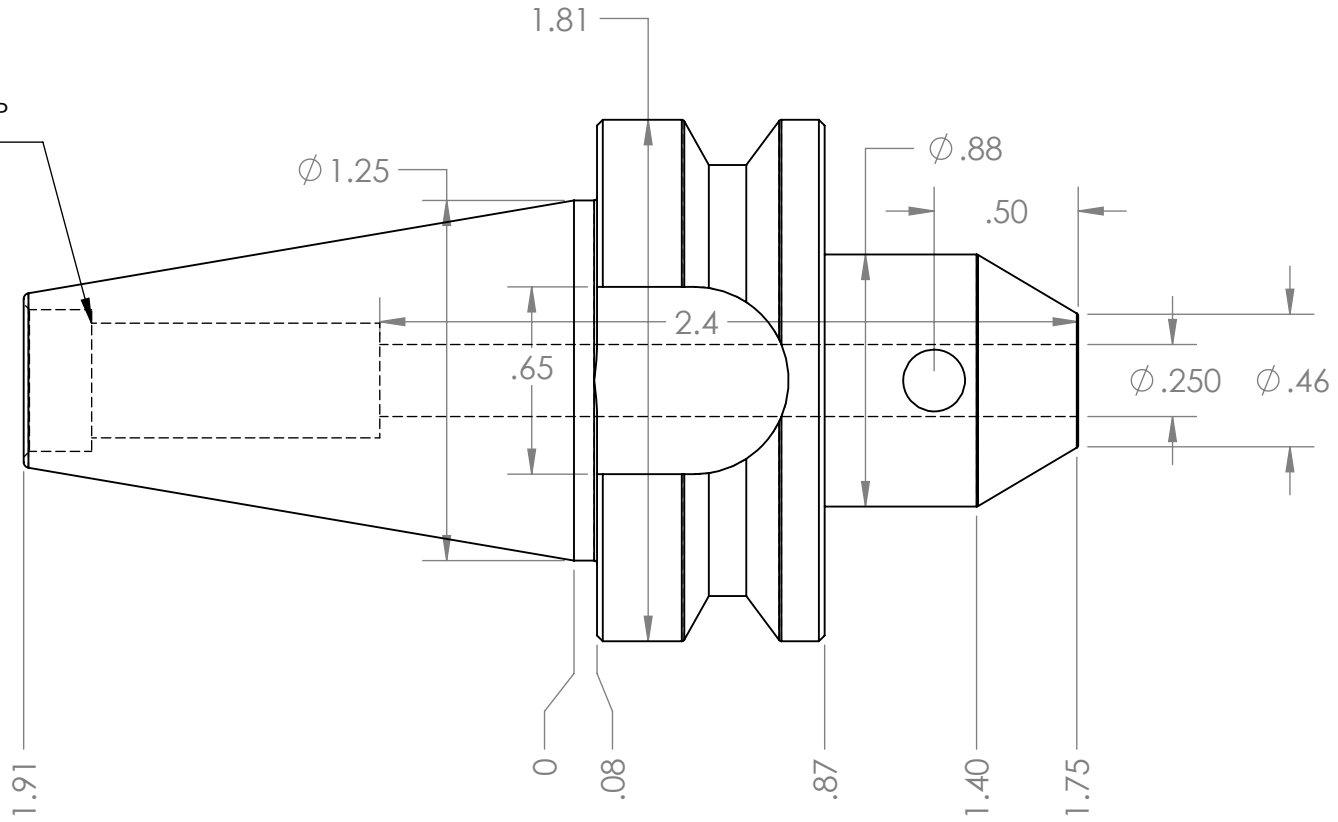

NOTES:
 HOLDER USES 1/4 - 28 SET SCREW, PART #SS060
 ACCEPTS .250 SHANK TOOLING
 FOR MORE PRODUCT DETAILS PLEASE GO TO MARITOO.COM
 AND SEARCH ITEM # LISTED ON THIS PRINT

MARITOO

WWW.MARITOO.COM

ITEM# **BT30 EM.250-1.75**

Made in USA