

5/8-11 THREAD x 1-1/8 DEEP  
Ø.642 C'BORE x .300 DEEP

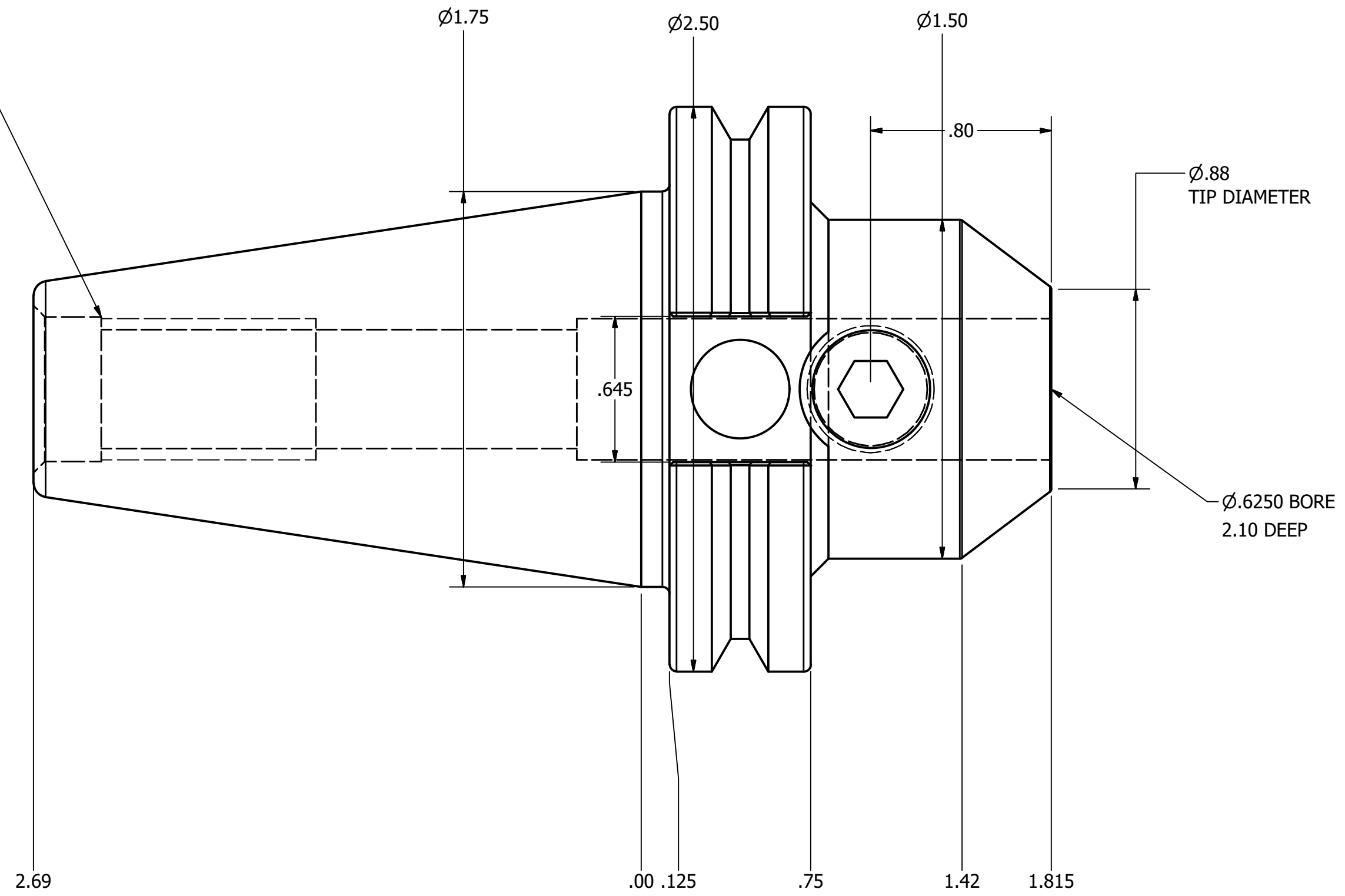

NOTES:  
HOLDER USES 9/16-18 SET SCREW, PART #SS210  
FOR MORE PRODUCT DETAILS PLEASE GO TO MARITOO.COM  
AND SEARCH ITEM # LISTED ON THIS PRINT

**MARITOO**

www.maritool.com

ITEM# **CAT40-EM.625-1.75**

Made in USA