

M12x1.75 THREAD x 1.00 DEEP
C'BORE DIA .492 x .236 DEEP

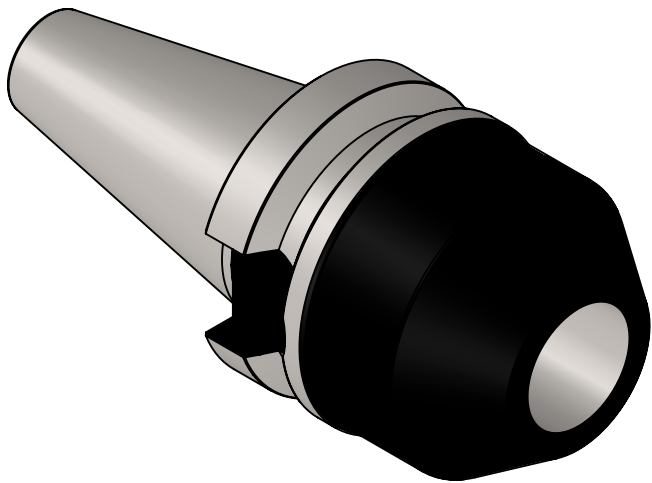
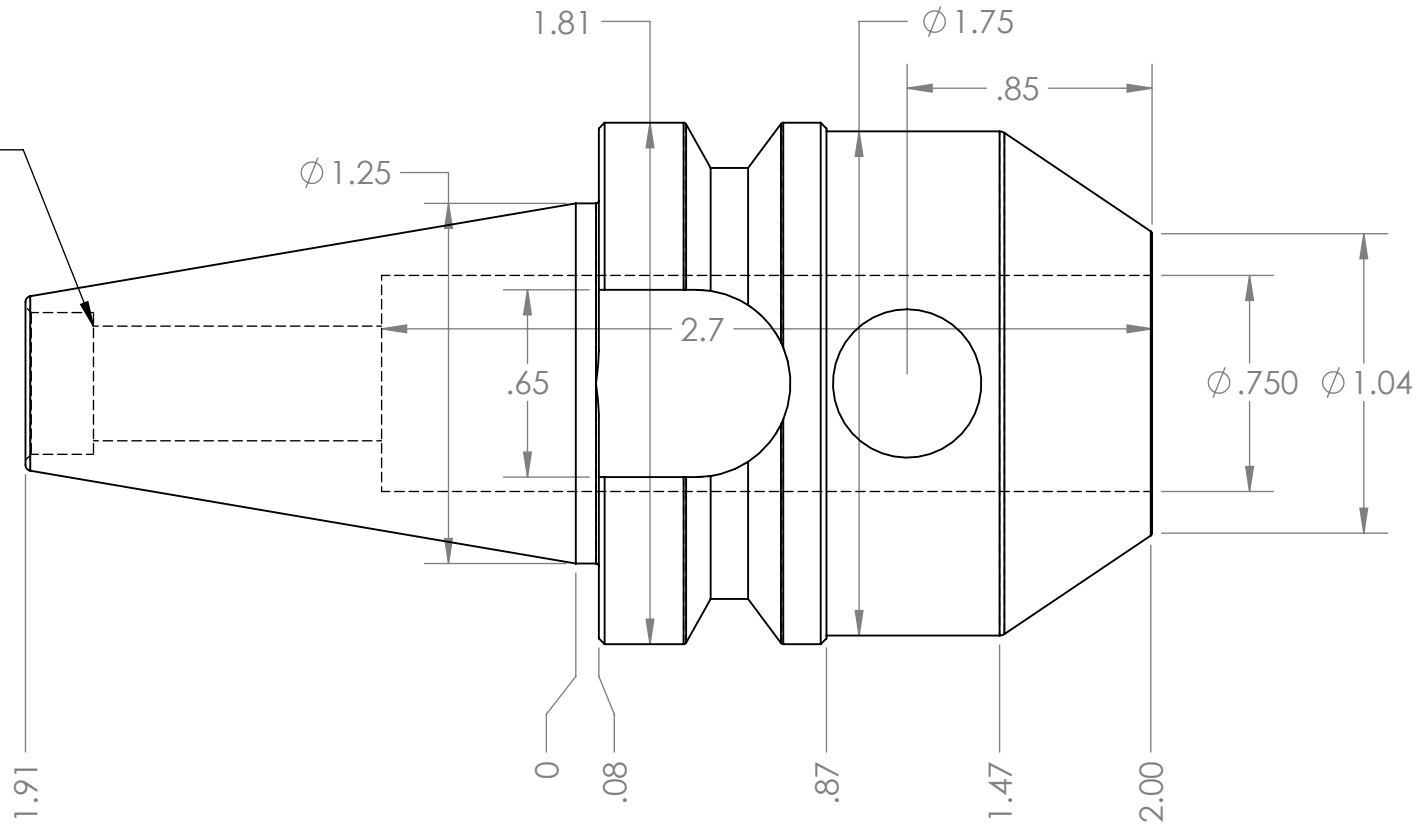

NOTES:
HOLDER USES 5/8 - 18 SET SCREW, PART #SS250
ACCEPTS .750 SHANK TOOLING
FOR MORE PRODUCT DETAILS PLEASE GO TO MARITOO.COM
AND SEARCH ITEM # LISTED ON THIS PRINT

MARITOO

WWW.MARITOO.COM

ITEM# **BT30 EM.750-2.0**

Made in USA